

## GXLA-US02B Unit Shelf Type "B"

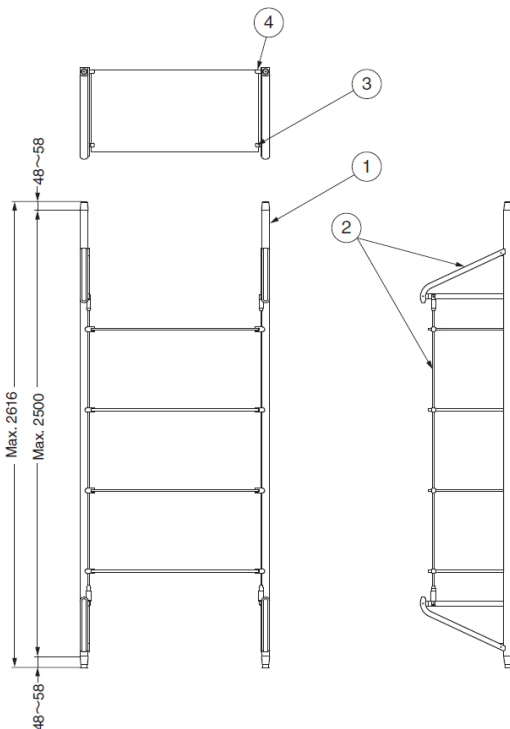

### Features

- Designed for top/bottom pressure fit installation with extendable levelling glide
- Can also be wall mounted by using optional wall mounting bracket
- Adjustable shelf height

### Application

- Shelf at store or house, showcase
- Walk-in closet

Part No.	Description
<b>GXLA-US02B</b>	Parts Set for 1 Shelf (comprises below items)

<b>Load Capacity N</b>	294 N/Shelf	
<b>Load Capacity kgf</b>	30 kgf/Shelf	
<b>Glass Thickness</b>	8 or 10	
<b>Glass Width</b>	Glass Width: 8 mm	Max. 1200
	Glass Width: 10 mm	Max. 1500
<b>Glass Depth</b>	400~450	
<b>Vertical-Frame Height</b>	2000~2500	

### Parts Included

	Item Name	Part Name	Qty
①	<b>GXLA-US02-S006</b>	Vertical Frame	2 sets
②	<b>GXL-US02-S011</b>	Wire Kit	2 sets
③	<b>GXL-US01-F20</b>	Shelf Clamp for Wire Shaft	8 pcs
④	<b>GXL-US01-B20</b>	Shelf Clamp for Main Frame	8 pcs

Glass is not included.

### Application Example



Can be used as glass partition by install glass panel at the back side

### Glass Shelf Dimensions

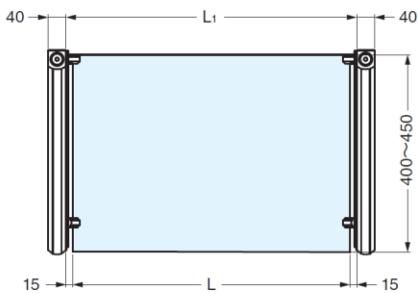

$L$  (Glass width) =  $L_1$  (Distance between frames) - 30

### Back Panel Installation

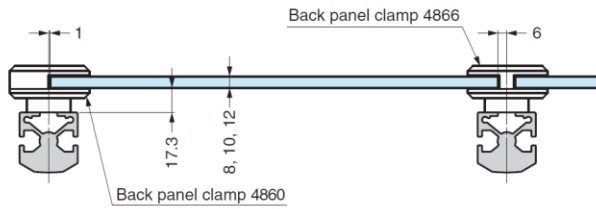

### Glass Preparation (When Using LED)

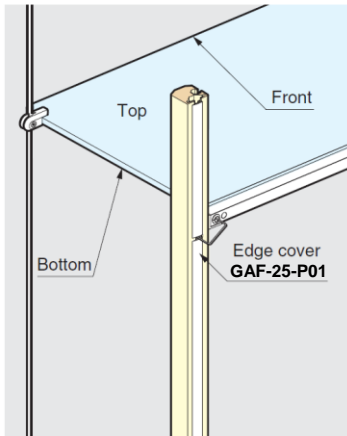

- Sandblasting on top, bottom, front and sides of glass shelf with use of LED will provide the "glow" look
- Ultra clear glass recommended
- Edge cover **GAF-25-P01** covers and keeps wires inside frame slot

■ Detailed View

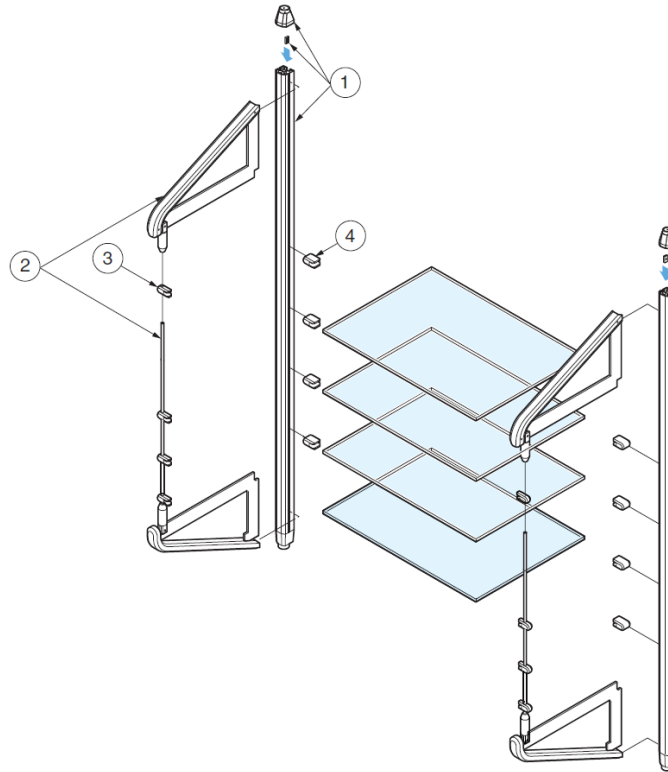





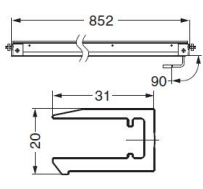



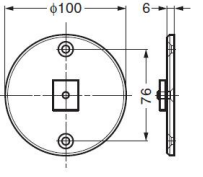

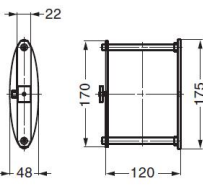

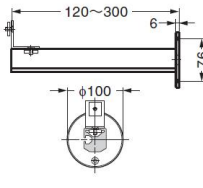
■ GXLA-US02B Part Details

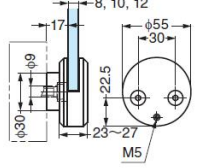
No.	Part No.		Dimensions	Type	Qty
①	<b>GXLA-US02-S006</b>	Vertical Frame (1 Slot Type)		<ul style="list-style-type: none"> <li>● Material: Aluminium, Zinc Alloy</li> <li>● Finish / Colour: Anodized, Grey</li> <li>● Length: Max. Height : 2600 mm (Floor to ceiling)</li> </ul>	1 set
②	<b>GXL-US02-S011-P</b>	Type B Wire Kit		<ul style="list-style-type: none"> <li>● Material: Aluminium, Steel, 430 Stainless Steel</li> <li>● Finish / Colour: Matte Chrome</li> <li>*For main frame 2100 mm ~ 2500 mm.</li> </ul>	1 set
③	<b>GXL-US01-F20</b>	Type B Shelf Clamp (For Wire Shaft)		<ul style="list-style-type: none"> <li>● Material: Zinc Alloy</li> <li>● Finish / Colour: Matte Chrome</li> <li>*2 pcs necessary for 1 shelf.</li> </ul>	1 pc
④	<b>GXL-US01-B20</b>	Type B Shelf Clamp (For Main Frame)		<ul style="list-style-type: none"> <li>● Material: Zinc Alloy</li> <li>● Finish / Colour: Matte Chrome</li> <li>*2 pcs necessary for 1 shelf.</li> </ul>	1 pc

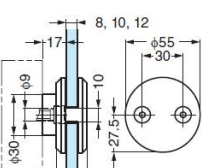
No.	Part No.		Dimensions	Type	Qty
⑤	<b>GXL-US01-W900L-B</b>	Shelf Support with Blue LED (For Main Frame 1 pc / shelf)	 	<ul style="list-style-type: none"> <li>● Aluminium Zinc Alloy</li> <li>● Width For glass width 900 mm</li> <li>● LED Colour Blue, White</li> <li>● Power adapter not included.</li> <li>*Recommended adapter Output : DC 24 V 1 A, Plug : 2.5 x 5.5 mm (+), 2 shelves per adapter</li> </ul>	1 pc
⑥	<b>GXL-US01-W900L-W</b>	Shelf Support with White LED (For Main Frame 1 pc / shelf)			

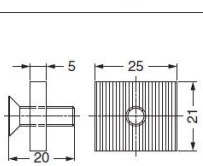
### ■ GXLA-US02B Optional Parts

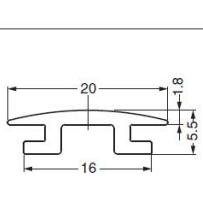
Part No.		Dimensions	Type	Qty
<b>GXL-US02-S010</b>	Wall Mounting Plate (For Type B)	 	<ul style="list-style-type: none"> <li>● Material Aluminium</li> <li>● Finish / Colour Anodized</li> <li>*To be used with main frame.</li> </ul>	1 pc
<b>GXL-US02-S008</b>	Wall Mounting Bracket	 	<ul style="list-style-type: none"> <li>● Material 304 Stainless Steel, Steel</li> <li>● Finish / Colour Grey</li> </ul>	1 pc
<b>GXL-US02-S009</b>	Wall Mounting Bracket	 	<ul style="list-style-type: none"> <li>● Material 304 Stainless Steel, Steel</li> <li>● Finish / Colour Anodized</li> </ul>	1 pc
<b>G4860ZN1</b>	Back Panel Clamp	 	<ul style="list-style-type: none"> <li>● Material Zinc Alloy</li> <li>● Finish / Colour Matte Chrome (ZN1) Chrome (ZN5)</li> <li>● Panel Thickness 8~12 mm</li> <li>*Holds panel between main frames.</li> </ul>	1 pc
<b>G4860ZN5</b>				
<b>G4866ZN1</b>	Back Panel Clamp	 	<ul style="list-style-type: none"> <li>● Material Zinc Alloy</li> <li>● Finish / Colour Matte Chrome (ZN1) Chrome (ZN5)</li> <li>● Panel Thickness 8~12 mm</li> <li>*Holds panel between main frames (2 slot type).</li> </ul>	1 pc
<b>G4866ZN5</b>				
<b>GXL-US02-S013</b>	Back Panel Clamp Fastener	 	<ul style="list-style-type: none"> <li>● Material 304 Stainless Steel</li> <li>● Finish / Colour Plain</li> <li>*Nut / Bolt to fasten back panel clamp and main frame.</li> </ul>	1 pc
<b>GAF-25-P01-25</b>	Edge Cover	 	<ul style="list-style-type: none"> <li>● Material Synthetic Rubber</li> <li>● Finish / Colour Light Grey</li> <li>● Length 2500 mm</li> </ul>	1 pc

※SCS13 is equivalent of SUS304.

## UNIT SHELF

Great variety of the optional parts for various spaces

- Simple design with aluminium alloy and glass
- Great variety of fashionable and functional parts
- Chamfered vertical frames and clamps in calm design
- Vertical frame is made of light and strong aluminium alloy
- Meets your requirements by combining the optional parts

### GXLA-US02B Unit Shelf Type “B”



- The shelf is hanged as it is floating
- The shelf is stable due to having it hold by the frame
- The glass shelf is in front of the frame, making it look neat

#### Optional Parts

Glass Thickness		Wood Shelf	Center Panel	Back Side Panel
8 mm	10 mm			
○	○	—	—	○

### GXLA-US02C Unit Shelf Type “C”

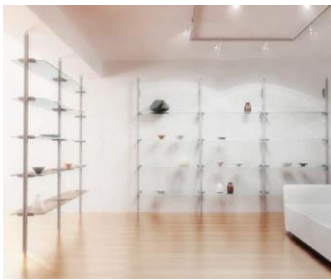

- Can also be used as partition

#### Optional Parts

Glass Thickness		Wood Shelf	Center Panel	Back Side Panel
8 mm	10 mm			
○	○	○	○	—

### GXLA-US02K Unit Shelf Type “K”



- The shelf is clamped from bottom on the frame
- Can also be used for wooden shelf

#### Optional Parts

Glass Thickness		Wood Shelf	Center Panel	Back Side Panel
8 mm	10 mm			
—	○	○	○	—



Fixable on wall.



Adjustable height by using the optional parts.

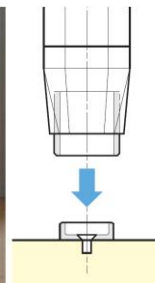

Prevents the slippage by using the optional part.



Wood shelf is also installable.



Cover for groove.

#### Suits various space

- Not only ceiling and floor but also fixable with wall and floor
- Wooden shelves are also installable
- Groove of the frame can be hidden with the original cover